

Varenummer: 437900062

Beskrivelse: Rota-fix spændelement SA 62

Mål

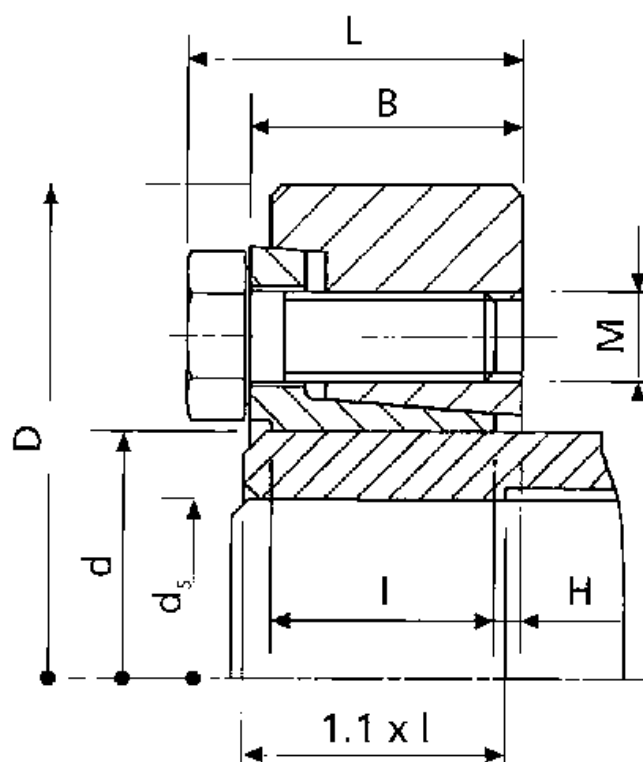

B mm	= 29.0
d H8 mm	= 62
D mm	= 110.0
ds mm	= 48
F kN aksialkraft	= 71
H	= 3.5
I mm	= 24.5
L mm	= 34.5

M mm	= M8
T Nm drejningsmoment	= 1700
Ts Nm boltetilspændingsmoment	= 30